

ONKYO

TX-8020

STEREO RECEIVER

INSTRUCTION MANUAL

Thank you for purchasing an Onkyo Stereo Receiver. Please read this manual thoroughly before making connections and plugging in the unit. Following the instructions in this manual will enable you to obtain optimum performance and listening enjoyment from your new Stereo Receiver. Please retain this manual for future reference.

Contents

IntroductionEn-2

Connections En-11

Enjoying Audio Sources..... En-19

Appendix
Troubleshooting En-32
Specifications En-34

WARNING:

TO REDUCE THE RISK OF FIRE OR ELECTRIC SHOCK, DO NOT EXPOSE THIS APPARATUS TO RAIN OR MOISTURE.

CAUTION:

TO REDUCE THE RISK OF ELECTRIC SHOCK, DO NOT REMOVE COVER (OR BACK). NO USER-SERVICEABLE PARTS INSIDE. REFER SERVICING TO QUALIFIED SERVICE PERSONNEL.



WARNING
RISK OF ELECTRIC SHOCK
DO NOT OPEN

AVIS
RISQUE DE CHOC ELECTRIQUE
NE PAS OUVRIR



The lightning flash with arrowhead symbol, within an equilateral triangle, is intended to alert the user to the presence of uninsulated "dangerous voltage" within the product's enclosure that may be of sufficient magnitude to constitute a risk of electric shock to persons.



The exclamation point within an equilateral triangle is intended to alert the user to the presence of important operating and maintenance (servicing) instructions in the literature accompanying the appliance.

Important Safety Instructions

1. Read these instructions.
2. Keep these instructions.
3. Heed all warnings.
4. Follow all instructions.
5. Do not use this apparatus near water.
6. Clean only with dry cloth.
7. Do not block any ventilation openings. Install in accordance with the manufacturer's instructions.
8. Do not install near any heat sources such as radiators, heat registers, stoves, or other apparatus (including amplifiers) that produce heat.
9. Do not defeat the safety purpose of the polarized or grounding-type plug. A polarized plug has two blades with one wider than the other. A grounding type plug has two blades and a third grounding prong. The wide blade or the third prong are provided for your safety. If the provided plug does not fit into your outlet, consult an electrician for replacement of the obsolete outlet.
10. Protect the power cord from being walked on or pinched particularly at plugs, convenience receptacles, and the point where they exit from the apparatus.
11. Only use attachments/accessories specified by the manufacturer.
12. Use only with the cart, stand, tripod, bracket, or table specified by the manufacturer, or sold with the apparatus. When a cart is used, use caution when moving the cart/apparatus combination to avoid injury from tip-over. 

PORTABLE CART WARNING
S3125A
13. Unplug this apparatus during lightning storms or when unused for long periods of time.
14. Refer all servicing to qualified service personnel. Servicing is required when the apparatus has been damaged in any way, such as power-supply cord or plug is damaged, liquid has been spilled or objects have fallen into the apparatus, the apparatus has been exposed to rain or moisture, does not operate normally, or has been dropped.
15. Damage Requiring Service
Unplug the apparatus from the wall outlet and refer servicing to qualified service personnel under the following conditions:
 - A. When the power-supply cord or plug is damaged,
 - B. If liquid has been spilled, or objects have fallen into the apparatus,
 - C. If the apparatus has been exposed to rain or water,
 - D. If the apparatus does not operate normally by following the operating instructions. Adjust only those controls that are covered by the operating instructions as an improper adjustment of other controls may result in damage and will often require extensive work by a qualified technician to restore the apparatus to its normal operation,
 - E. If the apparatus has been dropped or damaged in any way, and
 - F. When the apparatus exhibits a distinct change in performance this indicates a need for service.
16. Object and Liquid Entry
Never push objects of any kind into the apparatus through openings as they may touch dangerous voltage points or short-out parts that could result in a fire or electric shock.
The apparatus shall not be exposed to dripping or splashing and no objects filled with liquids, such as vases shall be placed on the apparatus.
Don't put candles or other burning objects on top of this unit.
17. Batteries
Always consider the environmental issues and follow local regulations when disposing of batteries.
18. If you install the apparatus in a built-in installation, such as a bookcase or rack, ensure that there is adequate ventilation.
Leave 20 cm (8") of free space at the top and sides and 10 cm (4") at the rear. The rear edge of the shelf or board above the apparatus shall be set 10 cm (4") away from the rear panel or wall, creating a flue-like gap for warm air to escape.

Precautions

1. **Recording Copyright**—Unless it's for personal use only, recording copyrighted material is illegal without the permission of the copyright holder.
2. **AC Fuse**—The AC fuse inside the unit is not user-serviceable. If you cannot turn on the unit, contact your Onkyo dealer.
3. **Care**—Occasionally you should dust the unit all over with a soft cloth. For stubborn stains, use a soft cloth dampened with a weak solution of mild detergent and water. Dry the unit immediately afterwards with a clean cloth. Don't use abrasive cloths, thinners, alcohol, or other chemical solvents, because they may damage the finish or remove the panel lettering.

4. Power

WARNING

BEFORE PLUGGING IN THE UNIT FOR THE FIRST TIME, READ THE FOLLOWING SECTION CAREFULLY.

AC outlet voltages vary from country to country. Make sure that the voltage in your area meets the voltage requirements printed on the unit's rear panel (e.g., AC 230 V, 50 Hz or AC 120 V, 60 Hz).

The power cord plug is used to disconnect this unit from the AC power source. Make sure that the plug is readily operable (easily accessible) at all times.

For models with [POWER] button, or with both [POWER] and [ON/STANDBY] buttons:

Pressing the [POWER] button to select OFF mode does not fully disconnect from the mains. If you do not intend to use the unit for an extended period, remove the power cord from the AC outlet.

For models with [ON/STANDBY] button only:

Pressing the [ON/STANDBY] button to select Standby mode does not fully disconnect from the mains. If you do not intend to use the unit for an extended period, remove the power cord from the AC outlet.

5. Preventing Hearing Loss

Caution

Excessive sound pressure from earphones and headphones can cause hearing loss.

6. Batteries and Heat Exposure

Warning

Batteries (battery pack or batteries installed) shall not be exposed to excessive heat as sunshine, fire or the like.

7. **Never Touch this Unit with Wet Hands**—Never handle this unit or its power cord while your hands are wet or damp. If water or any other liquid gets inside this unit, have it checked by your Onkyo dealer.

8. Handling Notes

- If you need to transport this unit, use the original packaging to pack it how it was when you originally bought it.
- Do not leave rubber or plastic items on this unit for a long time, because they may leave marks on the case.
- This unit's top and rear panels may get warm after prolonged use. This is normal.
- If you do not use this unit for a long time, it may not work properly the next time you turn it on, so be sure to use it occasionally.

For U.S. models

FCC Information for User

CAUTION:

The user changes or modifications not expressly approved by the party responsible for compliance could void the user's authority to operate the equipment.

NOTE:

This equipment has been tested and found to comply with the limits for a Class B digital device, pursuant to Part 15 of the FCC Rules. These limits are designed to provide reasonable protection against harmful interference in a residential installation.

This equipment generates, uses and can radiate radio frequency energy and, if not installed and used in accordance with the instructions, may cause harmful interference to radio communications. However, there is no guarantee that interference will not occur in a particular installation. If this equipment does cause harmful interference to radio or television reception, which can be determined by turning the equipment off and on, the user is encouraged to try to correct the interference by one or more of the following measures:

- Reorient or relocate the receiving antenna.
- Increase the separation between the equipment and receiver.
- Connect the equipment into an outlet on a circuit different from that to which the receiver is connected.
- Consult the dealer or an experienced radio/TV technician for help.

For Canadian Models

NOTE: THIS CLASS B DIGITAL APPARATUS COMPLIES WITH CANADIAN ICES-003.

For models having a power cord with a polarized plug:

CAUTION: TO PREVENT ELECTRIC SHOCK, MATCH WIDE BLADE OF PLUG TO WIDE SLOT, FULLY INSERT.

Modèle pour les Canadien

REMARQUE: CET APPAREIL NUMÉRIQUE DE LA CLASSE B EST CONFORME À LA NORME NMB-003 DU CANADA.

Sur les modèles dont la fiche est polarisée:

ATTENTION: POUR ÉVITER LES CHOCS ÉLECTRIQUES, INTRODUIRE LA LAME LA PLUS LARGE DE LA FICHE DANS LA BORNE CORRESPONDANTE DE LA PRISE ET POUSSER JUSQU'AU FOND.

For British models

Replacement and mounting of an AC plug on the power supply cord of this unit should be performed only by qualified service personnel.

IMPORTANT

The wires in the mains lead are coloured in accordance with the following code:

Blue: Neutral

Brown: Live

As the colours of the wires in the mains lead of this apparatus may not correspond with the coloured markings identifying the terminals in your plug, proceed as follows:

The wire which is coloured blue must be connected to the terminal which is marked with the letter N or coloured black.

The wire which is coloured brown must be connected to the terminal which is marked with the letter L or coloured red.

IMPORTANT

The plug is fitted with an appropriate fuse. If the fuse needs to be replaced, the replacement fuse must be approved by ASTA or BSI to BS1362 and have the same ampere rating as that indicated on the plug. Check for the ASTA mark or the BSI mark on the body of the fuse.

If the power cord's plug is not suitable for your socket outlets, cut it off and fit a suitable plug. Fit a suitable fuse in the plug.

For European Models

Declaration of Conformity

We declare, under our sole responsibility, that this product complies with the standards:

- Safety
- Limits and methods of measurement of radio disturbance characteristics
- Limits for harmonic current emissions
- Limitation of voltage changes, voltage fluctuations and flicker
- RoHS Directive, 2011/65/EU



Contents

| | | | |
|--|-----------|--|-----------|
| Important Safety Instructions | 2 | Recording | 23 |
| Precautions | 3 | Recording the Input Source..... | 23 |
| Features | 6 | Listening to the Radio | 24 |
| Supplied Accessories | 6 | Radio Frequency Setup..... | 24 |
| Installing the Batteries..... | 6 | Listening to AM/FM Stations..... | 25 |
| Aiming the Remote Controller..... | 6 | Using RDS (European model only)..... | 28 |
| Getting to Know the Receiver | 7 | iPod/iPhone Playback via Onkyo Dock | 30 |
| Front Panel..... | 7 | Using the Onkyo Dock..... | 30 |
| Rear Panel..... | 8 | Controlling Your iPod/iPhone..... | 31 |
| Display..... | 9 | Troubleshooting | 32 |
| Remote Controller..... | 10 | Power..... | 32 |
| Connecting the Receiver | 11 | Audio..... | 32 |
| Speaker Connection Precautions..... | 11 | Tuner..... | 32 |
| Connecting the Speaker Cables..... | 11 | Remote Controller..... | 32 |
| Connecting a Powered Subwoofer..... | 12 | Recording..... | 33 |
| Configuring the Speaker Impedance..... | 13 | Others..... | 33 |
| Connecting Antennas | 14 | Specifications | 34 |
| Connecting Your Components | 15 | | |
| About Connections..... | 15 | | |
| Connecting Onkyo RI Components..... | 17 | | |
| Connecting a Recording Component..... | 18 | | |
| Connecting the Power Cord..... | 18 | | |
| Turning On the Receiver | 19 | | |
| Turning On and Standby..... | 19 | | |
| Auto Standby..... | 19 | | |
| Enjoying Audio Sources | 20 | | |
| Selecting the Speaker Set..... | 20 | | |
| Muting the Receiver (remote controller only)..... | 20 | | |
| Using Headphones..... | 20 | | |
| Setting the Display Brightness..... | 21 | | |
| Using the Sleep Timer (remote controller only)..... | 21 | | |
| Using the Tone and Balance Controls..... | 21 | | |
| Displaying the Tone Level..... | 21 | | |
| Setting the DIRECT Function..... | 22 | | |
| Setting the Digital Audio Input (for European model)..... | 22 | | |

Features

- 50 Watts/Channel @ 8 Ω (FTC)
(For North American Model)
- 90 Watts/Channel @ 6 Ω (IEC)
(For European Model)
- WRAT (Wide Range Amplifier Technology)
- Discrete Amplifier Output Stage Circuitry
- Massive EI Transformer
- High-Current, Low-Impedance Drive
- Direct Mode
- 5 Analog Audio Inputs and 1 Output
- 3 Digital Audio Inputs (1 Optical, 2 Coaxial)
(European Model only)
- Phono Input for Turntable Connection
- Independent Bass, Treble, and Balance Controls
- Subwoofer Pre-Out
- Speaker A/B Terminals
- Remote Interactive (RI) Input for Integrated Control of Compatible Onkyo Components
- Headphone Jack
- 40 FM/AM Random Presets
- Preset Station Naming (Up to 8 Characters)
- RDS (PS/PTY/RT) (European Model only)
- 3-Mode Display Dimmer (Normal/Dim/Dimmer)
- Sleep Timer (via Remote)
- Battery-Free Memory Back-up
- Full-Sized, Full-Function RI Remote Control

Supplied Accessories

Make sure you have the following accessories:

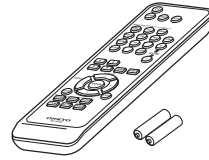

Remote controller and two batteries (AAA/R03)

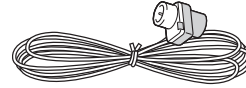

Indoor FM antenna

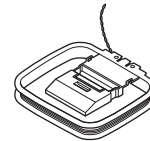

AM loop antenna

* In catalogs and on packaging, the letter at the end of the product name indicates the color. Specifications and operation are the same regardless of color.

Installing the Batteries

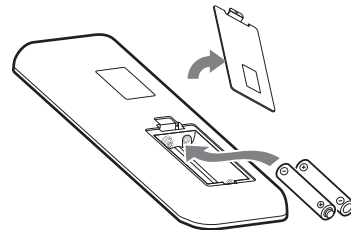

Notes:

- If the remote controller doesn't work reliably, try replacing the batteries.
- Don't mix new and old batteries or different types of batteries.
- If you intend not to use the remote controller for a long time, remove the batteries to prevent damage from leakage or corrosion.
- Expired batteries should be removed as soon as possible to prevent damage from leakage or corrosion.

Aiming the Remote Controller

When using the remote controller, point it toward the receiver's remote control sensor, as shown below.

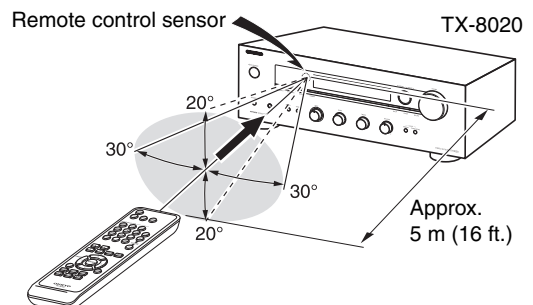

Getting to Know the Receiver

Front Panel

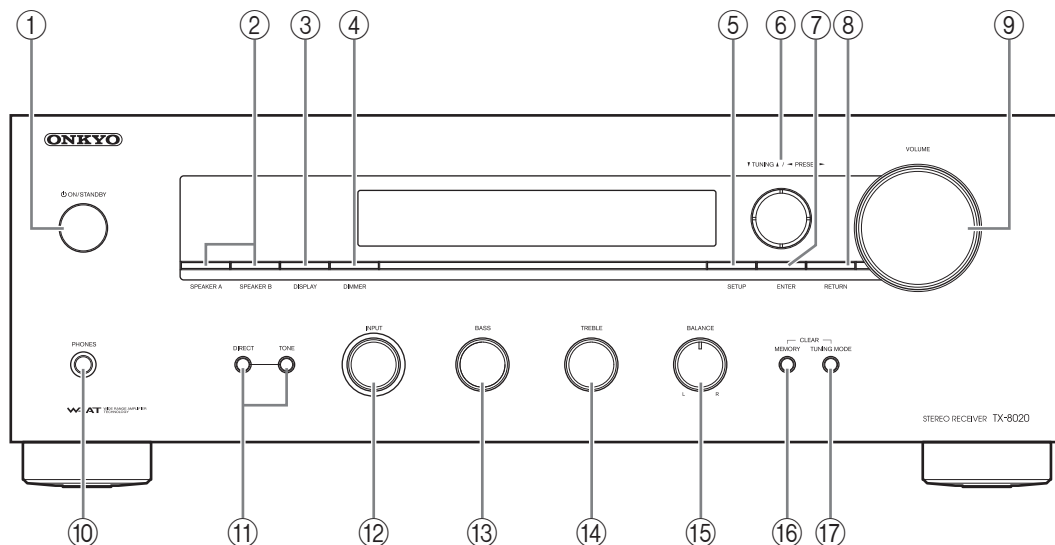

For detailed information, see the pages in parentheses.

- ① **ON/STANDBY button (19, 30, 32)**
- ② **SPEAKERS A and B buttons (20)**
- ③ **DISPLAY button (27, 29)**
- ④ **DIMMER button (21)**
- ⑤ **SETUP button (13, 19, 22, 24, 27)**
- ⑥ **TUNING ▲/▼, PRESET ◀/▶ buttons (25, 26, 29)**
- ⑦ **ENTER button (29)**
- ⑧ **RETURN button (13, 19, 22, 24, 27)**
- ⑨ **VOLUME control (20)**
- ⑩ **PHONES jack (20)**
- ⑪ **DIRECT, TONE buttons (21, 22)**
- ⑫ **INPUT selector (20, 23, 24, 25)**
- ⑬ **BASS control (21)**
- ⑭ **TREBLE control (21)**
- ⑮ **BALANCE control (21)**
- ⑯ **MEMORY button (26)**
- ⑰ **TUNING MODE button (25, 26, 32)**

Rear Panel

North American model

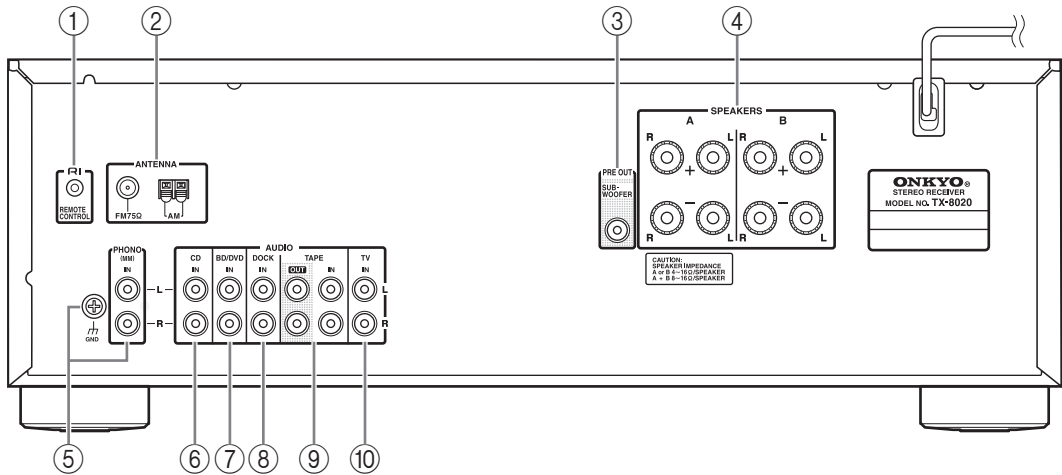

European model

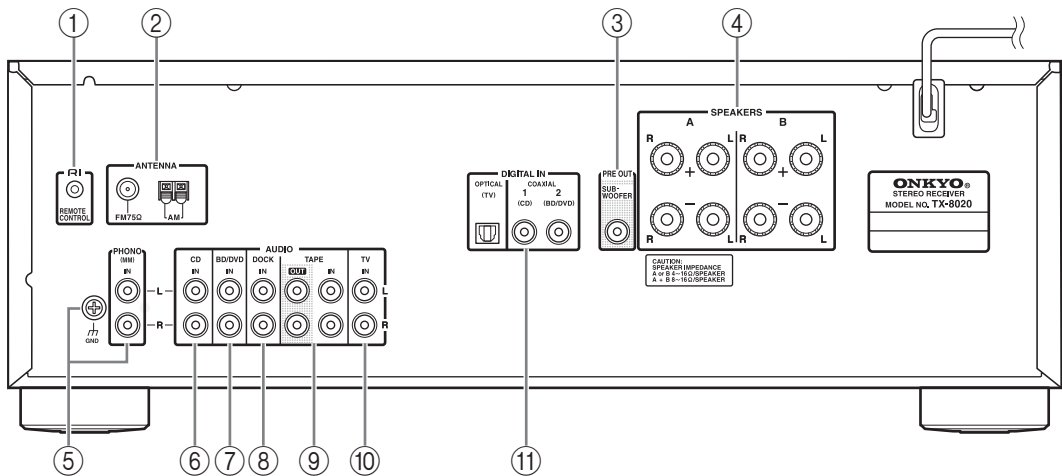

For detailed information, see the pages in parentheses.

- ① **RI REMOTE CONTROL** jack (17)
- ② **FM ANTENNA** jack and **AM ANTENNA** terminal (14)
- ③ **SUBWOOFER PRE OUT** jack (12)
- ④ **SPEAKERS A and B** terminals (11)
- ⑤ **PHONO IN (MM)** jacks and **GND** terminal (16)
- ⑥ **CD IN** jacks (16)
- ⑦ **BD/DVD IN** jacks (16)
- ⑧ **DOCK IN** jacks (16)
- ⑨ **TAPE IN/OUT** jacks (16, 18)
- ⑩ **TV IN** jacks (16)
- ⑪ **DIGITAL IN (OPTICAL, COAXIAL)** jacks (European model only) (16)

See “Connecting the Receiver” for connection (→ pages 11 to 18).

Display

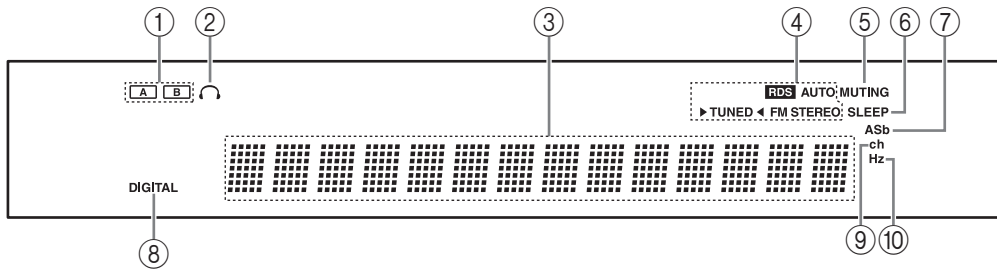

For detailed information, see the pages in parentheses.

- | | |
|--|---|
| ① A/B speaker indicators (20) | ⑤ MUTING indicator (32) |
| ② Headphone indicator | ⑥ SLEEP indicator (21) |
| ③ Message area | ⑦ ASb (Auto Standby) indicator (19) |
| ④ Tuning indicators | ⑧ Digital input indicator (European model) |
| • RDS indicator (European model) (28) | ⑨ ch indicator |
| • AUTO indicator (25) | ⑩ Hz indicator |
| • TUNED indicator (25) | |
| • FM STEREO indicator (25, 32) | |

Remote Controller

For detailed information, see the pages in parentheses.

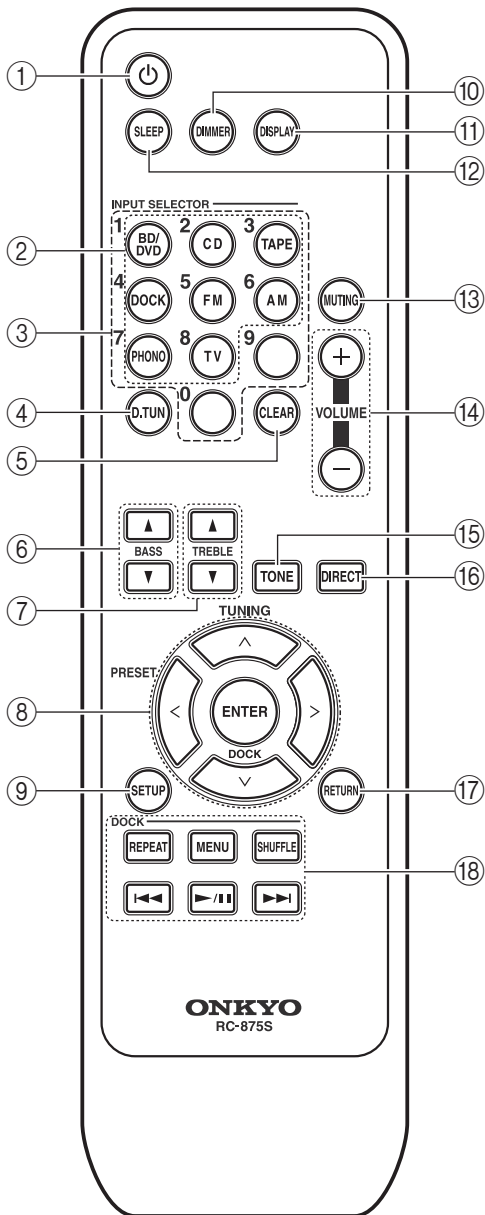

- ① **⏻ button (13, 19, 22)**
- ② **INPUT SELECTOR buttons (20, 23, 25, 31)**
- ③ **Number buttons (25, 26)**
- ④ **D.TUN button (25, 26)**
- ⑤ **CLEAR button (27)**
- ⑥ **BASS ▲/▼ buttons (21)**
- ⑦ **TREBLE ▲/▼ buttons (21)**
- ⑧ **Arrow [▲/▼/◀/▶] and ENTER buttons (13, 19, 22, 24, 26, 27, 31)**
- ⑨ **SETUP button (13, 19, 22, 24, 27)**
- ⑩ **DIMMER button (21)**
- ⑪ **DISPLAY button (27, 28, 29)**
- ⑫ **SLEEP button (21)**
- ⑬ **MUTING button (20)**
- ⑭ **VOLUME +/- buttons (20)**
- ⑮ **TONE button (21)**
- ⑯ **DIRECT button (22)**
- ⑰ **RETURN button (13, 19, 22, 24, 27, 31)**
- ⑱ **DOCK Control buttons (31)**

Connecting the Receiver

⚠ **Disconnect the power cord from the electrical outlet before making any connections.**

Speaker Connection Precautions

The receiver allows you to connect two sets of speakers. When two sets of speakers are connected, you can select which speaker set outputs sound or use both sets to output sound simultaneously. (→ page 20 about “Speakers A” and “Speakers B”)

- When you connect one set of speakers to either SPEAKERS A or SPEAKERS B terminal posts, or when you connect two sets of speakers to both speaker terminal posts and output sound only from either speaker set, use speakers whose impedance is 4 to 16 Ω , and set the speaker impedance setting on the receiver to 4 or 6 Ω (→ page 13). When the impedance of the speaker to be used is less than 6 Ω , set the speaker impedance to 4 Ω .
- When you connect speakers to both SPEAKERS A and SPEAKERS B terminal posts and output sound from both speaker sets simultaneously, use speakers whose impedance is 8 to 16 Ω . Set the speaker impedance setting on the receiver to 4 Ω .
- Read the instructions supplied with your speakers.
- Pay close attention to speaker wiring polarity. In other words, connect positive (+) terminals only to positive (+) terminals, and negative (–) terminals only to negative (–) terminals. If you get them the wrong way around, the sound will be out of phase and will sound unnatural.
- Unnecessarily long or very thin speaker cables may affect the sound quality and should be avoided.
- Be careful not to short the positive and negative wires. Doing so may damage the receiver.

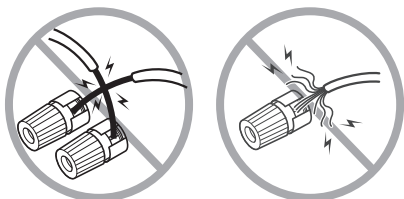

- Don't connect more than one cable to each speaker terminal. Doing so may damage the receiver.
- Don't connect a speaker to more than one pair of speaker terminals.

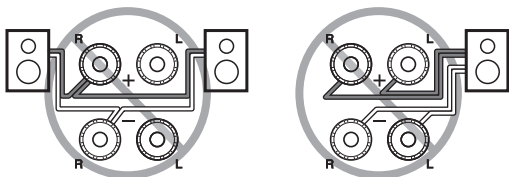

Note:

If you make an incorrect setting for the speakers or the impedance values, the built-in protection circuit may be activated resulting in no sound output from speakers.

Connecting the Speaker Cables

- 1 Strip about 5/8" (15 mm) of insulation from the ends of the speaker cables, and twist the bare wires tightly, as shown.**

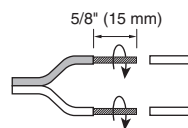

- 2 Unscrew the terminal.**



- 3 Fully insert the bare wire.**



- 4 Screw the terminal tight.**



The following illustration shows which speaker should be connected to each pair of terminals.

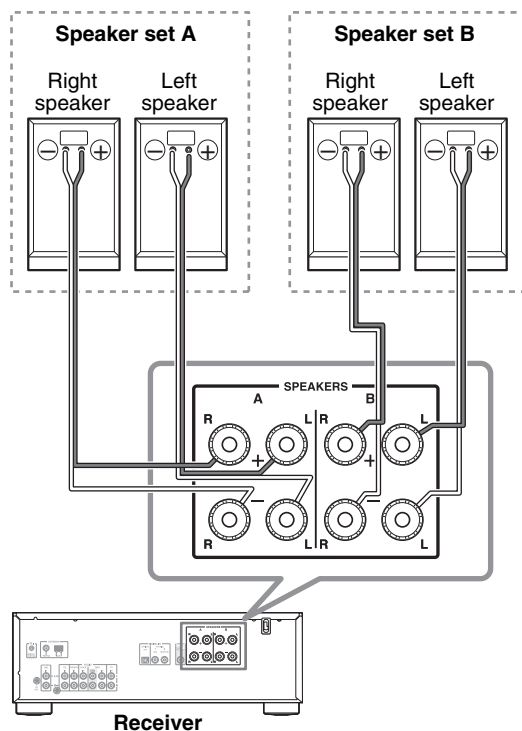

Connecting a Powered Subwoofer

Using a suitable cable, connect the receiver's SUBWOOFER PRE OUT to the input on your powered subwoofer. If your subwoofer is unpowered and you're using an external amplifier, connect the SUBWOOFER PRE OUT to the amp's input.

Note:

SUBWOOFER PRE OUT is linked to SPEAKER A's On/Off. When SPEAKER A is selected, the audio signal will output from the SUBWOOFER PRE OUT.

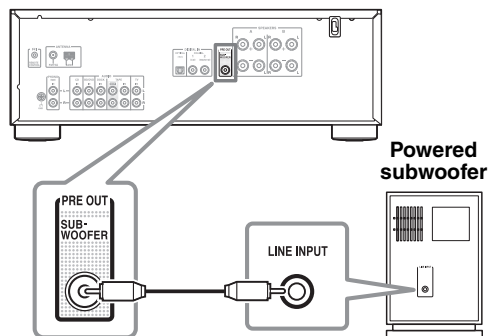

Configuring the Speaker Impedance

On the receiver, the factory default for speaker impedance is “6 Ω”. If you need to change the speaker impedance setting, read “Speaker Connection Precautions” on page 11 carefully before performing the procedure below.

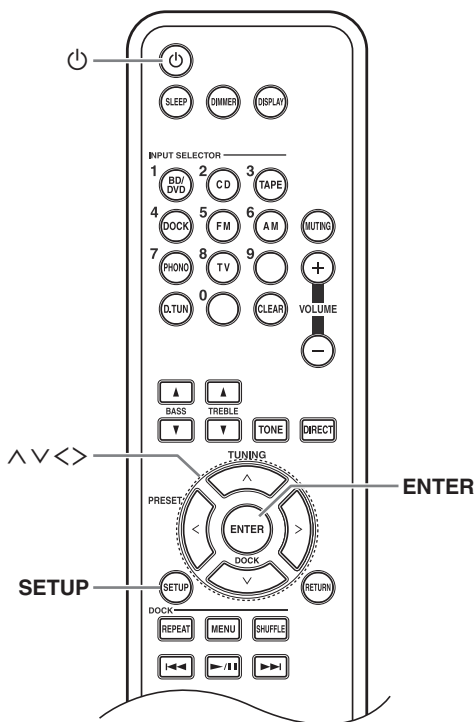

Note:

Be sure to minimize the volume level on the receiver before configuring the speaker impedance.

1 Press the [⏻] button to turn on the power.

2 Press the [SETUP] button on the remote controller.

3 Use the arrow [^]/[v] buttons to select “SP Impedance,” and then press [ENTER].

SP Impedance

4 Change the impedance value to “4 Ω” using the arrow [←]/[→] buttons.

5 Press the [ENTER] button to confirm the setting.

Complete

If you want to change the impedance setting back to the factory default setting of 6 Ω, follow the same procedure described above.

6 Press the [SETUP] button on the remote controller to complete the setting.

Notes:

- This procedure can also be performed on the receiver by using [SETUP], TUNING [▲]/[▼], PRESET [◀]/[▶], and [ENTER].
- Press [RETURN] to return to the previous menu.
- This procedure will be cancelled if the [SETUP] button is pressed before step **5**.

Setting example:

If you're using only one of the speaker sets connected to SPEAKERS A or B, choose the 4 Ω setting if each speaker's impedance is 4 Ω to less than 6 Ω, or choose the 6 Ω setting if each speaker's impedance is 6 Ω or more.

If you're using both of the speaker sets connected to SPEAKERS A and B, choose the 4 Ω setting if each speaker's impedance is 8 to 16 Ω.

Connecting Antennas

This section explains how to connect the supplied indoor FM antenna and AM loop antenna.

The receiver won't pick up any radio signals if no antenna is connected, so you must connect the antenna to use the tuner.

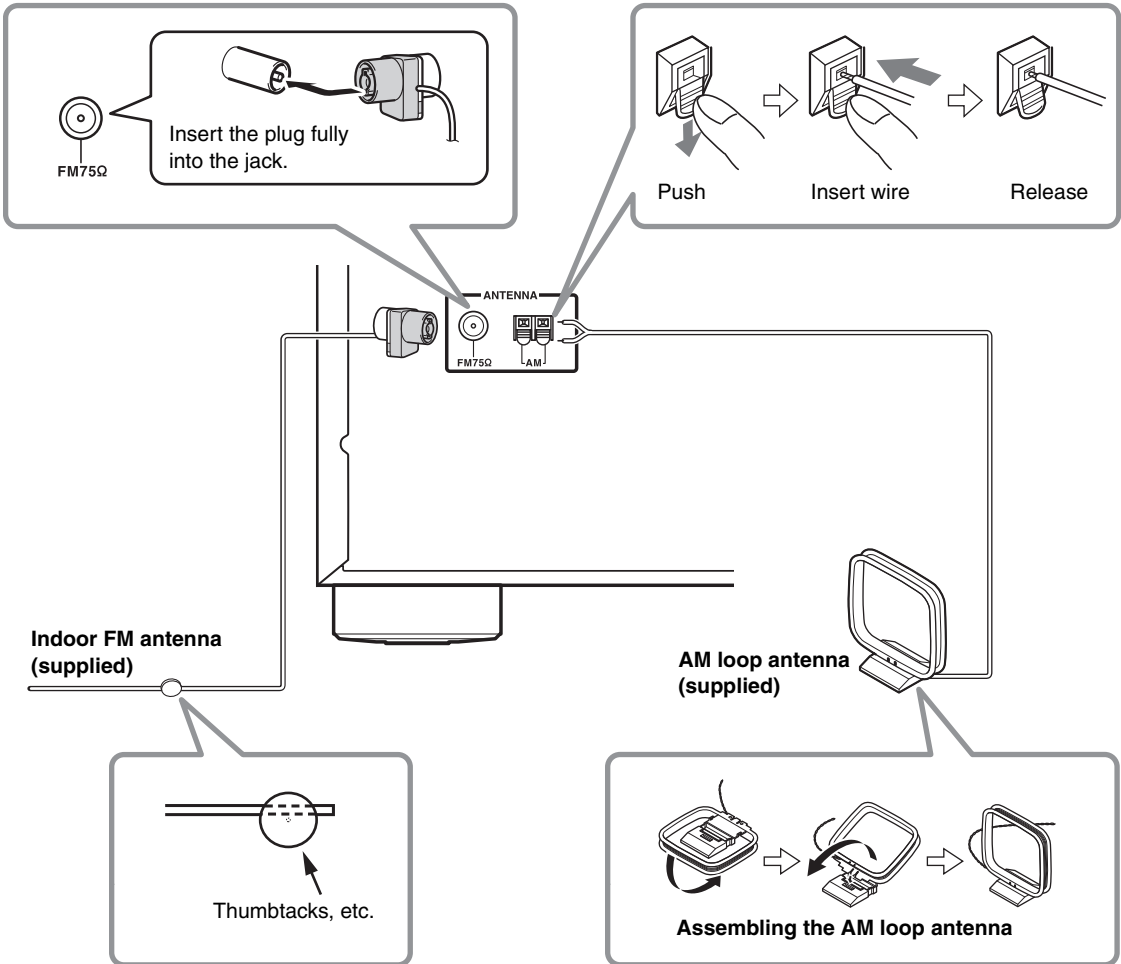

Caution:

Be careful that you don't injure yourself when using thumbtacks.

Notes:

- Once your receiver is ready for use, you'll need to tune into a radio station and position the antenna to achieve the best possible reception.
- Keep the AM loop antenna as far away as possible from your receiver, TV, speaker cables, and power cords.
- Refer to "Radio Frequency Setup" on page 24 for more information on switching the frequency setup.

Tips:

- If you cannot achieve good reception with the supplied indoor FM antenna, try a commercially available outdoor FM antenna instead.
- If you cannot achieve good reception with the supplied indoor AM loop antenna, try using it with a commercially available outdoor AM antenna.

Connecting Your Components

About Connections

Connecting components

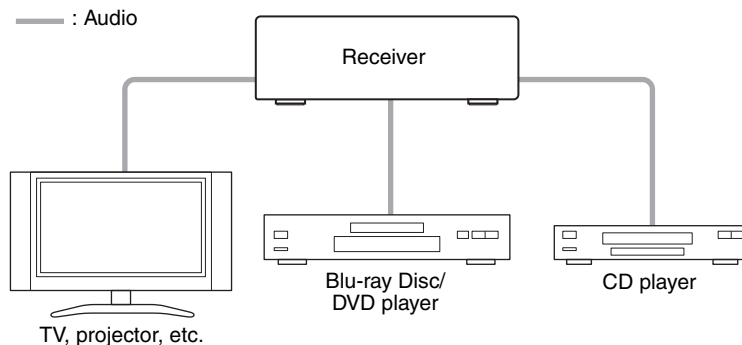

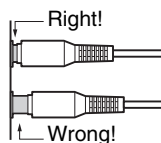

- Before making any connections, read the manuals supplied with your components.
- Don't connect the power cord until you've completed and double-checked all connections.
- Push plugs in all the way to make good connections (loose connections can cause noise or malfunctions).



- To prevent interference, keep audio cable away from power cords and speaker cables.

Cables and Jacks

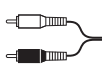
| Signal | Cable | Jack | Description |
|--------|---|---|---|
| Audio | Optical digital audio (European model only) |  OPTICAL | Optical digital connections allow you to enjoy digital sound. The audio quality is the same as coaxial. |
| | Coaxial digital audio (European model only) |  COAXIAL Orange | Coaxial digital connections allow you to enjoy digital sound. The audio quality is the same as optical. |
| | Analog audio (RCA) |  L White R Red | Analog audio connections (RCA) carry analog audio. |

Notes:

- The receiver does not support multichannel audio input. The PCM signal can be input only to digital input terminals. Make sure that PCM is selected on the playback component.
- The receiver's optical digital jacks have shutter-type covers that open when an optical plug is inserted and close when it's removed. Push plugs in all the way.

Caution:

To prevent shutter damage, hold the optical plug straight when inserting and removing.

Connecting Your Components—Continued

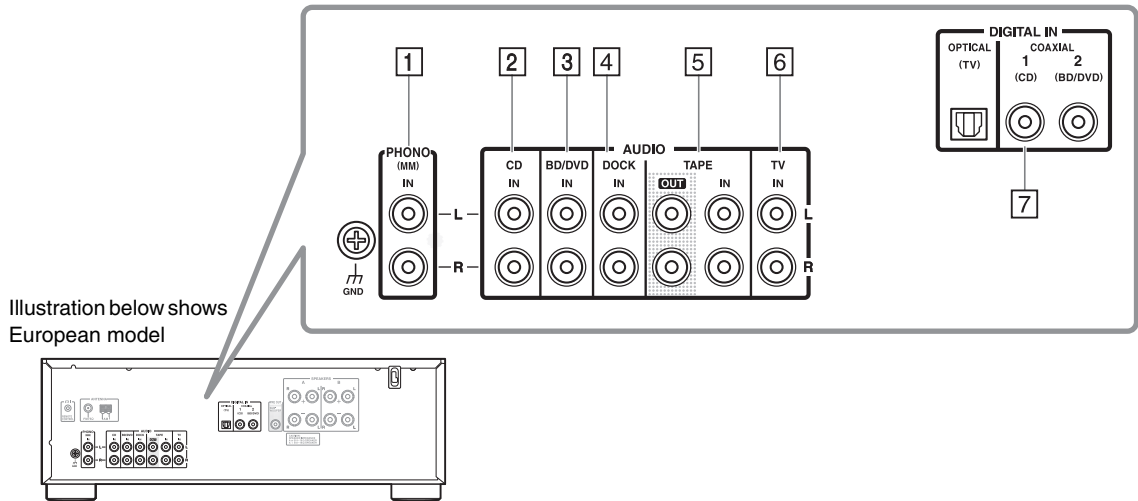

| No. | Jack | Connectable components |
|-----|--|------------------------------------|
| 1 | PHONO IN | Turntable |
| 2 | CD IN | CD player, Turntable |
| 3 | BD/DVD IN | Blu-ray Disc/DVD player |
| 4 | DOCK IN | RI dock |
| 5 | TAPE IN | Cassette tape deck |
| 6 | TV IN | TV |
| 7 | DIGITAL IN (OPTICAL, COAXIAL) (European model only) | OPTICAL: TV COAXIAL: CD, BD/DVD |

Notes:

- **Refer to the connected component's instruction manual for details.**
- Connect a turntable (MM) that has a built-in phono preamp to **CD IN**, or connect it to **PHONO IN** with the phono preamp turned off. If your turntable (MM) doesn't have a phono preamp, connect it to **PHONO IN**. If your turntable has a moving coil (MC) type cartridge, you'll need a commercially available MC head amp or MC transformer to connect to **PHONO IN**. See your turntable's manual for details. If your turntable has a ground wire, connect it to the **GND** screw. With some turntables, connecting the ground wire may produce an audible hum. If this happens, disconnect it.
- If your Blu-ray Disc/DVD player has both main stereo and multichannel outputs, be sure to connect the main stereo output using connection **3**.

Connecting Onkyo RI Components

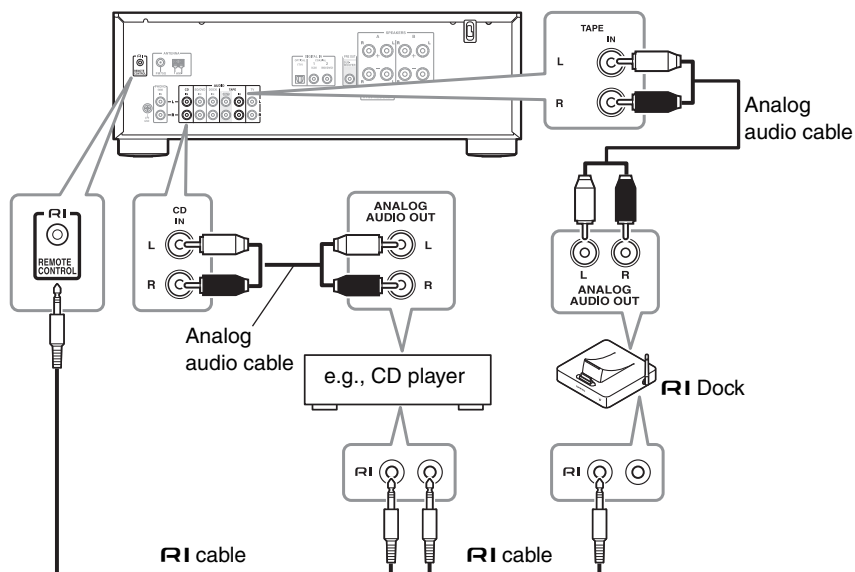

1 Make sure that each Onkyo component is connected with an analog audio cable (→ page 16).

2 Make the RI connection (see the illustration).

- Connect only Onkyo components to **RI** jacks. Connecting other manufacturer's components may cause a malfunction.
- Some components may not support all **RI** functions. Refer to the manuals supplied with your Onkyo components.

With **RI** (Remote Interactive), you can use the following special functions:

■ System On/Auto Power On

When you start playback on a component connected via **RI**, while the receiver is on Standby, the receiver will automatically turn on and select that component as the input source.

■ Direct Change

When playback is started on a component connected via **RI**, the receiver automatically selects that component as the input source.

■ Remote Control

You can use the receiver's remote controller to control your other **RI** Dock, pointing the remote controller at the receiver's remote control sensor instead of the component.

Notes:

- Use only **RI** cables for **RI** connections. **RI** cables are supplied with Onkyo players (CD, etc.).
- Some components have two **RI** jacks. You can connect either one to the receiver. The other jack is for connecting additional **RI**-capable components.

Connecting a Recording Component

See “Recording” for an explanation of recording (→ page 23).

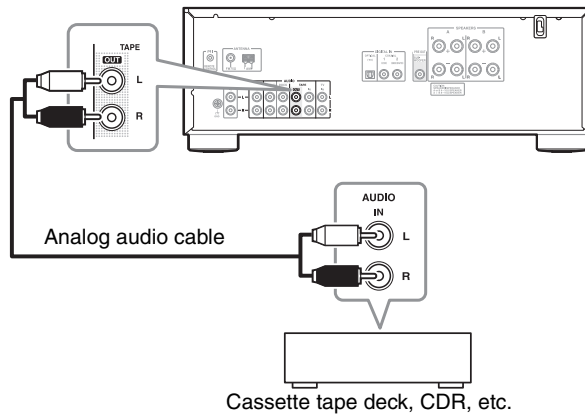

Notes:

- The receiver must be turned on for recording. Recording is not possible while it's in Standby mode.
- For European model, sources connected to a digital input cannot be recorded. Only analog inputs can be recorded.
- DTS signals will be recorded as noise, so don't attempt analog recording of DTS CDs or LDs.

Connecting the Power Cord

Connect the receiver's power cord to a suitable wall outlet.

Notes:

- **Before connecting the power cord, connect all of your speakers and components.**
- Turning on the receiver may cause a momentary power surge that might interfere with other electrical equipment on the same circuit. If this is a problem, plug the receiver into a different branch circuit.

Turning On the Receiver

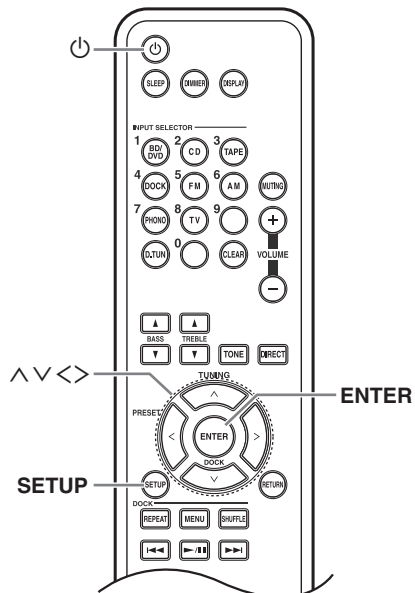
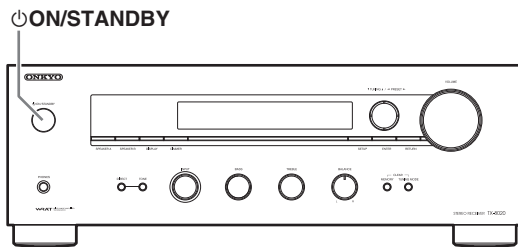

Turning On and Standby

Press the [⏻ ON/STANDBY] button. Alternatively, press the remote controller's [⏻] button.

The receiver comes on, and the display lights up.

To turn the receiver off, press the [⏻ ON/STANDBY] button, or press the remote controller's [⏻] button. The receiver will enter Standby mode. To prevent any loud surprises when you next turn on the receiver, always turn down the volume before you turn it off.

Auto Standby

When "Auto Standby" is set to "On," the receiver will automatically enter Standby mode if there is no operation for 30 minutes with no audio signal input. Default setting: Off (North American model)
On (European model)

Notes:

- If you're listening at a low volume, the Auto Standby function may detect this as silence.
- With some sources, the Auto Standby function may activate itself during playback.

1 Press the [⏻] button to turn on the power.

2 Press the [SETUP] button on the remote controller.

3 Use the arrow [^]/[v] buttons to select "Auto Standby," and then press [ENTER].

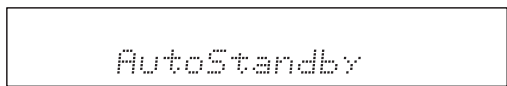

4 Switch the ASb On/ASb Off using the arrow [<]/[>] buttons.

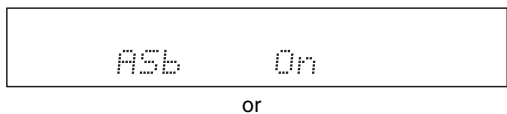

or



5 Press the [ENTER] button to confirm the setting.

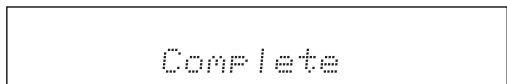

6 Press the [SETUP] button on the remote controller to complete the setting.

Notes:

- This procedure can also be performed on the receiver by using [SETUP], TUNING [^]/[v], PRESET [◀]/[▶], and ENTER.
- Press [RETURN] to return to the previous menu.
- This procedure will be cancelled if the [SETUP] button is pressed before step 5.

Enjoying Audio Sources

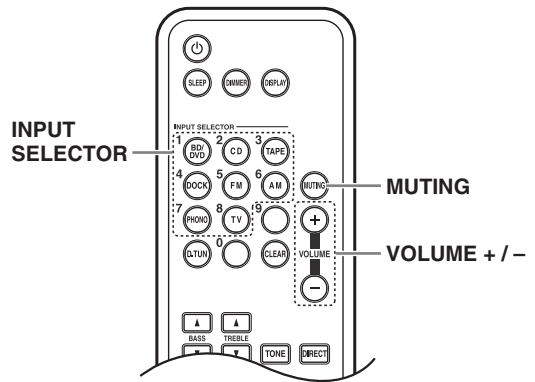
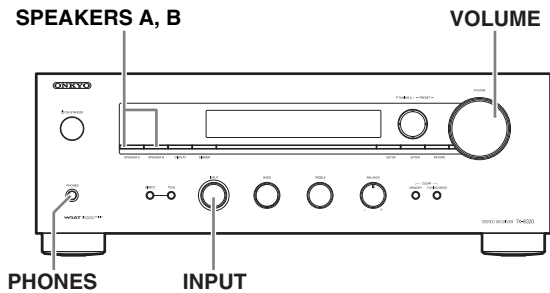

Selecting the Speaker Set

- 1 Rotate the receiver's [INPUT] selector, or press the remote controller's INPUT SELECTOR buttons to select the source you want to hear.
- 2 Use the [SPEAKERS A] and [SPEAKERS B] buttons on the receiver to select the speaker set that you want to use.

The A and B speaker indicators show whether each speaker set is on or off.

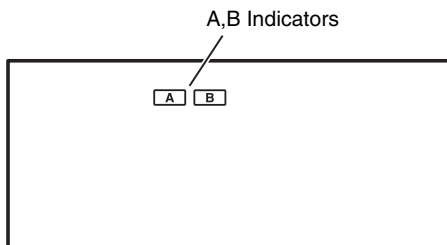

- 3 Start playback on the selected component.

- 4 To adjust the volume, use the receiver's [VOLUME] control, or the remote controller's VOLUME [+]/[-] buttons.

Turn the control clockwise to turn up the volume or counterclockwise to turn down the volume.

Muting the Receiver (remote controller only)

You can temporarily mute the output of the receiver.

Press the remote controller's [MUTING] button.

The receiver is muted.

To unmute the receiver, press the [MUTING] button again.

Note:

The Mute function will be cancelled if the remote controller's VOLUME [+]/[-] buttons are pressed or the receiver is set to Standby.

Using Headphones

You can connect a pair of stereo headphones (1/4-inch phone plug) to the receiver's PHONES jack for private listening.

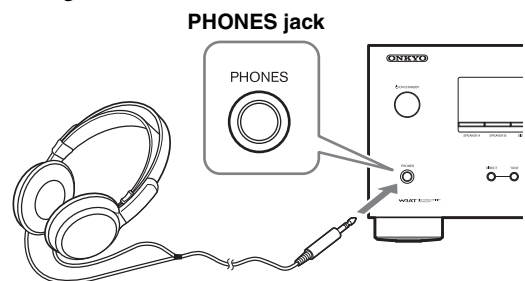

Notes:

- Always turn down the volume before connecting your headphones.
- While the headphones plug is inserted in the PHONES jack, the speakers are turned off.

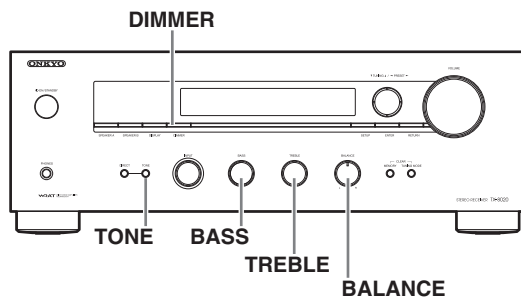
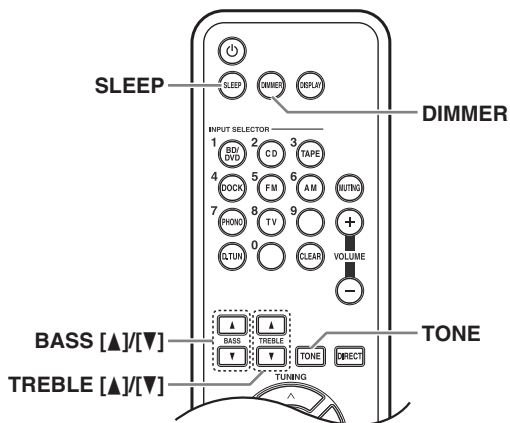

Setting the Display Brightness

You can adjust the brightness of the display.

Press the [DIMMER] button repeatedly to select: dim, dimmer, or normal brightness.

Using the Sleep Timer (remote controller only)

With the sleep timer, you can set the receiver so that it turns off automatically after a specified period.

Press the remote controller's [SLEEP] button repeatedly to select the required sleep time.

You can set the sleep time from 90 to 10 minutes in 10 minute steps. At this time, by using the remote controller's [▲]/[▼] buttons, you can set the time in 1 minute steps.

The SLEEP indicator appears on the display when the sleep timer has been set, as shown. The specified sleep time appears on the display for about 5 seconds; then the previous display reappears.

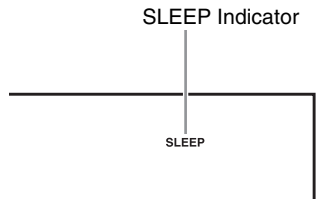

To cancel the sleep timer, press the [SLEEP] button repeatedly until the SLEEP indicator disappears.

To check the remaining sleep time, press the [SLEEP] button. Note that if you press the [SLEEP] button while the sleep time is being displayed, you'll shorten the sleep time by 10 minutes.

Using the Tone and Balance Controls

This section explains the following functions that can be used with any input source.

Adjusting the Bass

You can adjust the Bass sounds by rotating the [BASS] control on the receiver or pressing the remote controller's BASS [▲]/[▼] buttons. You can set the level from -6 to +6. Set it higher to make them louder. Set it lower to make them quieter.

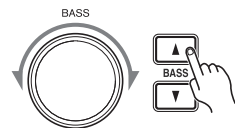

Adjusting the Treble

You can adjust the Treble sounds by rotating the [TREBLE] control on the receiver or pressing the remote controller's TREBLE [▲]/[▼] buttons. You can set the level from -6 to +6. Set it higher to make them louder. Set it lower to make them quieter.

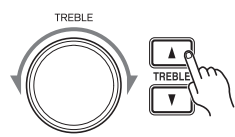

Adjusting the Balance

The [BALANCE] control is used to control the relative volume level of the left and right speaker systems.

Note:
If headphones are connected, the BALANCE control has no effect.

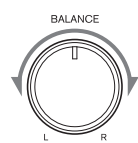

Displaying the Tone Level

You can check the tone level by pressing the [TONE] button repeatedly.

The display will change as follows each time you press the [TONE] button.

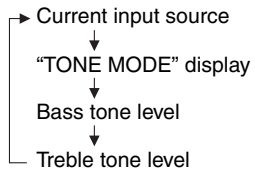

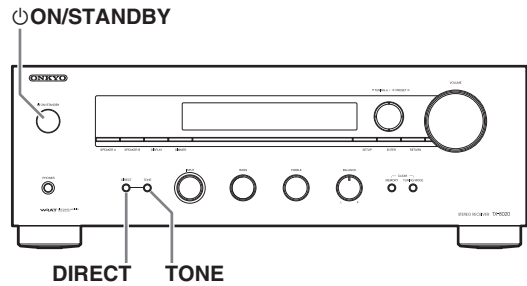
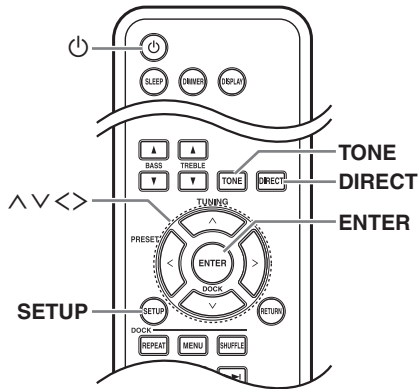

Setting the DIRECT Function

Press the [DIRECT] button. The message “DIRECT MODE” appears.



When the DIRECT function is on, the tone controls are bypassed, so you can enjoy pure sound.

To cancel the DIRECT function, press the [TONE] button again, and the message “TONE MODE” appears.

The tone controls can be used to adjust the sound.

You can configure whether the DIRECT function is applied or not for input sources individually.

Setting the Digital Audio Input (for European model)

If you connect a component to a digital audio input, you must assign that input to an input selector. For example, if you connect your RI Dock to the OPTICAL, you must assign “OPT” to the “DOCK” input selector.

Here are the default assignments.

| Input selector | Default assignment |
|----------------|--------------------|
| BD/DVD | COAX2 |
| TV | OPT |
| TAPE | ----- |
| DOCK | ----- |
| CD | COAX1 |

COAX1, COAX2, OPT:

Select the corresponding digital audio input, to which the component has been connected.

-----:

Select if the component is connected to an analog audio input.

Note:

The maximum sampling rate for PCM signals from a digital input (optical and coaxial) is 96 kHz/24 bit.

1 Press the [POWER] button to turn on the power.

2 Press the [SETUP] button on the remote controller.

3 Use the arrow [UP]/[DOWN] buttons to select “Digital Input,” and then press [ENTER].

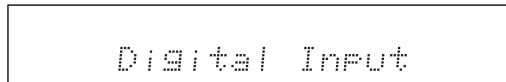

4 Press the arrow [UP]/[DOWN] buttons to select the input that you want to change the assignment.

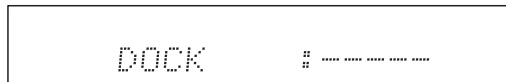

For example, select “DOCK” to assign to “OPT”.

5 Press the arrow [LEFT]/[RIGHT] buttons to select an input terminal.



For example, select “OPT”.

6 Press the [ENTER] button to confirm the setting.

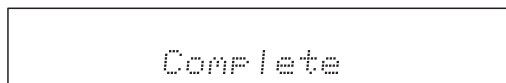

7 Press the [SETUP] button on the remote controller to complete the setting.

Notes:

- This procedure can also be performed on the receiver by using [SETUP], TUNING [UP]/[DOWN], PRESET [LEFT]/[RIGHT], and [ENTER].
- Press [RETURN] to return to the previous menu.
- This procedure will be cancelled if the [SETUP] button is pressed before step **6**.

Recording

Unless you have the full consent of the copyright holder, copyright laws prohibit using your recordings for anything other than personal enjoyment!

This section explains how to record the selected input source to a component with recording capability, and how to record audio from different sources.

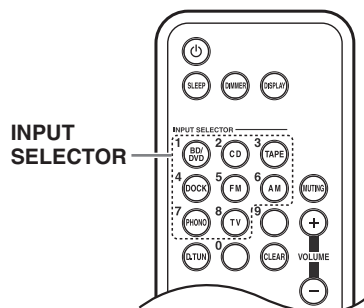
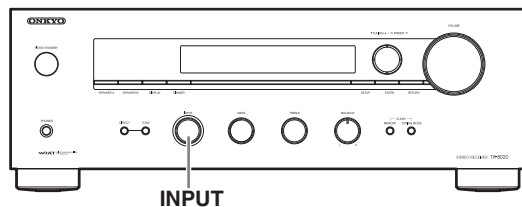

Recording the Input Source

Audio sources can be recorded to a recorder (e.g., cassette tape deck, CDR).

1 Prepare the recorder:

- Set the recorder so that it's ready for recording.
- If necessary, adjust the recording level on the recorder.
- See the recorder's manual for more information.

2 Use the receiver's [INPUT] selector, or the remote controller's INPUT SELECTOR buttons to select the component that you want to record from.

3 Start playback on the component selected in step 1.

Notes:

- If you select another input source during recording, the newly selected input source will be recorded.
- The volume, balance, mute and tone controls have no effect on the signal being recorded.

Listening to the Radio

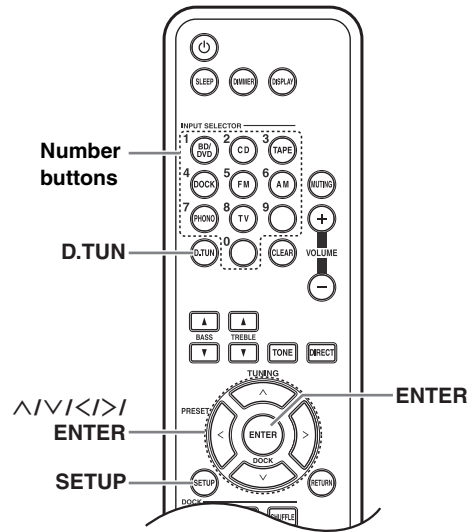
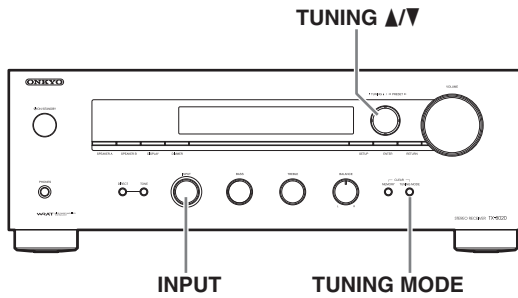

Radio Frequency Setup

For radio tuning to work properly, you must specify the radio frequency step used in your area.

Note that when this setting is changed, all radio presets are deleted.

North American model (AM/FM):

10 kHz/200 kHz (default setting) or 9 kHz/ 50 kHz

European model (AM):

9 kHz (default setting) or 10 kHz

- 1 Use the receiver's [INPUT] selector, or the remote controller's INPUT SELECTOR buttons to select AM or FM.

- 2 Press the [SETUP] button on the remote controller.

- 3 Use the arrow [^]/[v] buttons to select "AM/FM FreqStep" (North American model) or "AM Freq Step" (European model), and then press [ENTER].

North American model

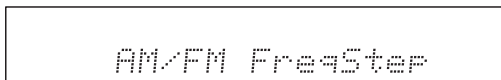

European model

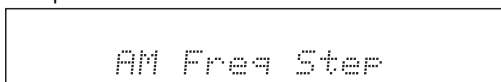

- 4 Use the arrow [←]/[→] buttons to specify the frequency.

North American model

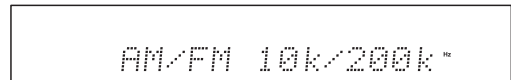

European model

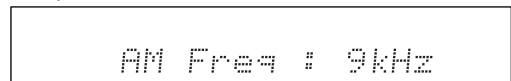

- 5 Press the [ENTER] button to confirm the setting.

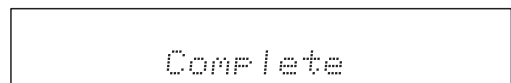

- 6 Press the [SETUP] button on the remote controller to complete the setting.

Notes:

- This procedure can also be performed on the receiver by using [SETUP], TUNING [▲]/[▼], PRESET [◀]/[▶], and [ENTER].
- Press [RETURN] to return to the previous menu.
- This procedure will be cancelled if the [SETUP] button is pressed before step 5.

Listening to AM/FM Stations

With the built-in tuner, you can enjoy AM and FM radio stations.

- 1 Use the receiver's [INPUT] selector, or the remote controller's INPUT SELECTOR buttons to select AM or FM.**

In this example, FM has been selected.

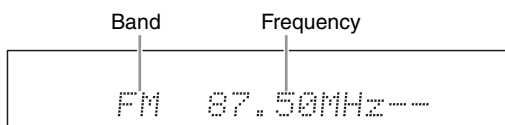

(Actual display depends on the country.)

- 2 Press the [TUNING MODE] button so that the AUTO indicator appears or disappears from the display.**

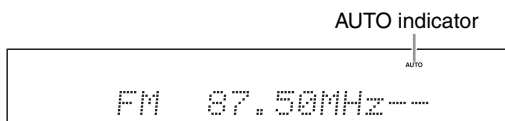

Auto Tuning

To activate this mode, press the [TUNING MODE] button to turn on the “AUTO” indicator. In this mode, you will receive the broadcast in stereo sound.

Manual Tuning

To activate this mode, press the [TUNING MODE] button to turn off the “AUTO” indicator. In this mode, you will receive the broadcast in monaural sound.

- 3 Press the TUNING [▲] or [▼] button.**

You can also use the remote controller's arrow [^]/[v] buttons to tune the radio.

Auto Tuning

Searching stops when a station is found.

Manual Tuning

The frequency stops changing when you release the button.

Press the buttons repeatedly to change the frequency one step at a time.

The frequency changes in 0.05 MHz steps (or 0.05 MHz to 0.2 MHz for North American model) for FM, and 9 kHz (or 10 kHz) steps for AM.

When tuned to a station, the TUNED indicator appears. When tuned to a stereo FM station, the FM STEREO indicator also appears.

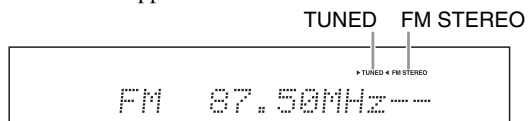

Tuning to Weak FM Stereo Stations

If the signal from a stereo FM station is weak, it may be impossible to get good reception. In this case, switch to Manual Tuning mode and listen to the station in mono.

■ Tuning into Stations by Frequency

You can tune to AM and FM stations directly by entering the appropriate frequency.

- 1 Press the remote controller's [D.TUN] button twice.**



(Actual display depends on the country.)

- 2 Within 8 seconds, use the number buttons to enter the frequency of the radio station.**

For example, to tune to 87.50 (FM), press 8, 7, 5, 0.

Presetting AM/FM Stations

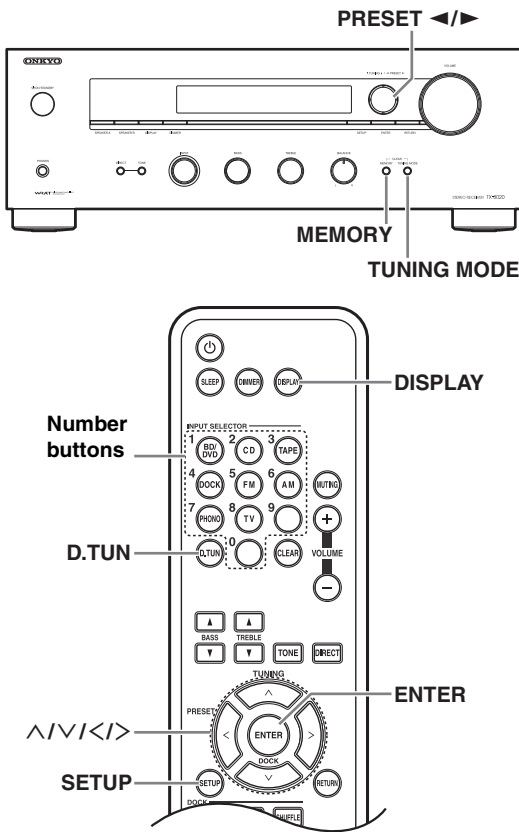

You can store up to 40 of your favorite AM/FM radio stations as presets.
 Presetting FM/AM stations is performed by the receiver.

1 Tune to the AM/FM station that you want to store as a preset.

2 Press the [MEMORY] button.
 The preset number flashes.

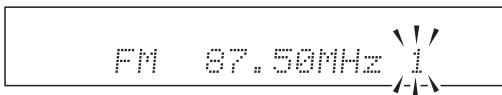

3 While the preset number flashes (about 8 seconds), use the PRESET [◀]/[▶] buttons to select a preset from 1 through 40.

4 Press the [MEMORY] button again to store the station or channel.

The station or channel is stored and the preset number stops flashing.
 Repeat this procedure for all of your favorite AM/FM radio stations.

■ **Selecting Presets**

To select a preset, use the remote controller's arrow [◀]/[▶] buttons or the receiver's PRESET [◀]/[▶] buttons.

■ **Selecting Preset by entering Preset number**
 You can tune to AM and FM stations directly by entering the appropriate preset number.

1 Press the remote controller's [D.TUN] button.

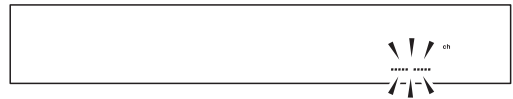

(Actual display depends on the country.)

2 Within 8 seconds, use the number buttons to enter the preset number of the radio station.

■ **Deleting Presets**

1 Select the preset that you want to delete.
 See the previous section.

2 While holding down the [MEMORY] button, press the [TUNING MODE] button.
 The preset is deleted and its number disappears from the display.

Listening to the Radio—Continued

■ Name Edit

You can enter a custom name for radio preset for easy identification. When entered, the custom name will appear on the display.

The custom name is edited using the character input screen.

1 Select the preset that you want to edit the name.

2 Press the [SETUP] button on the remote controller.

3 Use the arrow [^]/[v] button to select “Name Edit,” and then press [ENTER].

4 Use the arrow [^]/[v]/[<]/[>] button to select a character, and then press [ENTER].

Repeat this step to enter up to 8 characters.

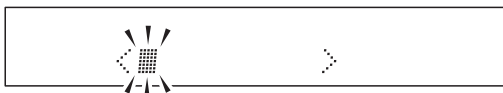

5 When you’ve finished editing the name and want to store it, be sure to use the arrow [^]/[v]/[<]/[>] button to select “OK” and then press [ENTER]. If you fail to do this, the name won’t be saved.

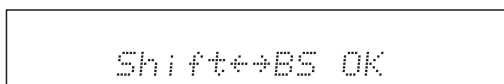

See the following table for information about the character strings that can be input.

There are two patterns of character string: pattern 1 containing mainly lowercase characters, and pattern 2 containing mainly uppercase characters.

You can use the ▲/▼ buttons to select character strings within each pattern. Use the ◀/▶ buttons to select the character that you want to input, and press the ENTER button. If the displayed character string pattern does not contain the character you want to input, use the ▲/▼ buttons to display the [Shift←→BS OK] character string, use the ◀/▶ buttons to

select “Shift,” and press the ENTER button to make the other character string pattern appear.

1

| | | | | | | | | | | | | | |
|---|---|---|---|---|---|---|---|---|---|---|---|---|---|
| a | b | c | d | e | f | g | h | i | j | k | l | m | |
| n | o | p | q | r | s | t | u | v | w | x | y | z | |
| 1 | 2 | 3 | 4 | 5 | 6 | 7 | 8 | 9 | 0 | - | = | ` | |
| { | } | ! | : | ” | < | > | ? | S | p | a | c | e | |
| S | h | i | f | t | < | - | - | > | B | S | | O | K |

2

| | | | | | | | | | | | | | |
|---|---|---|----|---|---|---|---|---|---|---|---|---|---|
| A | B | C | D | E | F | G | H | I | J | K | L | M | |
| N | O | P | Q | R | S | T | U | V | W | X | Y | Z | |
| ! | @ | # | \$ | % | ^ | & | * | (|) | _ | + | ~ | |
| [|] | \ | : | ' | , | . | / | S | p | a | c | e | |
| S | h | i | f | t | < | - | - | > | B | S | | O | K |

Shift*1:

Switches the displayed character.

←(Left)/→(Right):

Select these to move the cursor within the Name input area.

Space:

Enters a space character.

BS (Back Space)*2:

“Back Space” moves the cursor backward one character space. In addition, “Back Space” deletes the character to the left of the cursor.

OK:

Specifies that the entry is complete.

Tips:

- *1 You can also perform this on the remote controller by using [D.TUN].
- *2 By pressing [CLEAR] on the remote controller, you can delete all characters in the input.

6 Press the [SETUP] button on the remote controller to complete the setting.

Notes:

- This procedure can also be performed on the receiver by using [SETUP], TUNING [▲]/[▼], PRESET [◀]/[▶], and [ENTER].
- Press [RETURN] to return to the previous menu.
- This procedure will be cancelled if the [SETUP] button is pressed before step 5.

■ Switching the Display

When receiving AM or FM, you can press the remote controller’s [DISPLAY] button to switch the display between the name you specified in Name Edit and the frequency that’s being received.

Using RDS (European model only)

RDS only works in areas where RDS broadcasts are available. When tuned into an RDS station, the RDS indicator appears.



■ What is RDS?

RDS stands for Radio Data System and is a method of transmitting data embedded in FM radio signals. It was developed by the European Broadcasting Union (EBU) and is available in most European countries. Many FM stations use it these days. In addition to displaying text information, RDS can also help you find radio stations by type (e.g., news, sport, rock, etc.).

The receiver supports three types of RDS information:

PS (Program Service)

When tuned to an RDS station that's broadcasting PS information, the station's name will be displayed.

RT (Radio Text)

When tuned to an RDS station that's broadcasting text information, the text will be shown on the display (→ page 29).

PTY (Program Type)

This allows you to search for RDS radio stations by type (→ page 29).

Notes:

- In some cases, the text characters displayed on the receiver may not be identical to those broadcast by the radio station. Also, unexpected characters may be displayed when unsupported characters are received. This is not a malfunction.
- If the signal from an RDS station is weak, RDS data may be displayed intermittently or not at all.

■ Switching the Display

When tuned to RDS stations, you can press the remote controller's [DISPLAY] button to switch the information shown in the display.

The display will change as follows each time you press the [DISPLAY] button.

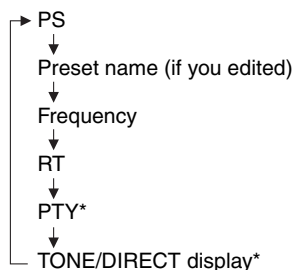

* If you don't press the [DISPLAY] button for 3 seconds, the display will change to PS.

RDS Program Types (PTY)

| Type | Display |
|--------------------------|----------|
| None | NONE |
| News reports | NEWS |
| Current affairs | AFFAIRS |
| Information | INFO |
| Sport | SPORT |
| Education | EDUCATE |
| Drama | DRAMA |
| Culture | CULTURE |
| Science and technology | SCIENCE |
| Varied | VARIED |
| Pop music | POP M |
| Rock music | ROCK M |
| Middle of the road music | EASY M |
| Light classics | LIGHT M |
| Serious classics | CLASSICS |
| Other music | OTHER M |
| Weather | WEATHER |
| Finance | FINANCE |
| Children's programmes | CHILDREN |
| Social affairs | SOCIAL |
| Religion | RELIGION |
| Phone in | PHONE IN |
| Travel | TRAVEL |
| Leisure | LEISURE |
| Jazz music | JAZZ |
| Country music | COUNTRY |
| National music | NATION M |
| Oldies music | OLDIES |
| Folk music | FOLK M |
| Documentary | DOCUMENT |
| Alarm test | TEST |
| Alarm | ALARM |

Displaying Radio Text (RT)

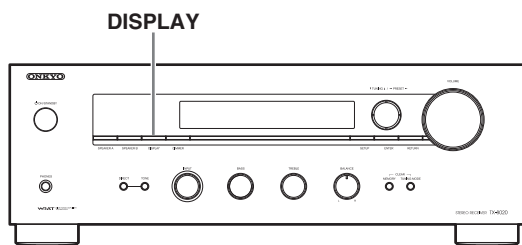

When tuned to an RDS station that's broadcasting text information, the text can be displayed.

Use the [DISPLAY] button to display RT.

The RT information scrolls across the display.

Notes:

- The message "Waiting" may appear while the receiver waits for the RT information.
- If the message "No Text Data" appears on the display, no RT information is available.

Finding Stations by Type (PTY)

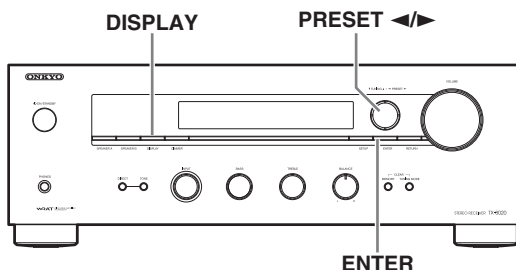

You can search for radio stations by type.

1 Use the [DISPLAY] button to display PTY.

The current program type appears on the display.

Note:

If you tuned to another station than RDS, "Not RDS" will appear.

2 Use the PRESET [◀]/[▶] buttons to select the type of program you want.

See the table on page 28.

Note:

If you don't press the buttons for 3 seconds, the display will return to the previous display.

3 To start the search, press [ENTER].

The receiver searches until it finds a station of the type you specified, at which point it stops briefly before continuing with the search.

4 When a station you want to listen to is found, press [ENTER].

If no stations are found, the message "Not Found" appears.

iPod/iPhone Playback via Onkyo Dock

Using the Onkyo Dock

Dock is sold separately. Models sold are different depending on the region.

For the latest information on Onkyo Dock components, see the Onkyo web site at:
<http://www.onkyo.com>

Before using an Onkyo Dock, update your iPod/iPhone with the latest software, available from the Apple web site.

For supported iPod/iPhone models, see the instruction manual of the Onkyo Dock.

Operating Notes

- Use the receiver's volume control to adjust the playback volume.
- While your iPod/iPhone is inserted in the RI Dock, its volume control has no effect.
- If you do adjust the volume control on your iPod/iPhone while it's inserted in the RI Dock, be careful that it's not set too loud before you reconnect your earphones.

Note:

On the iPod with video and iPod nano (1st generation), the click wheel is disabled during playback.

RI Dock

With the RI Dock, you can easily play the music stored on your Apple iPod/iPhone through the receiver and enjoy great sound. You can even use the receiver's remote controller to operate your iPod/iPhone.

Notes:

- Connect the RI Dock to the receiver with an **RI** cable (→ page 17).
- Set the RI Dock's RI MODE switch to "HDD" or "HDD/DOCK".

■ System Function

System On

When you turn on the receiver, the RI Dock and your iPod/iPhone turn on automatically. In addition, when the RI Dock and iPod/iPhone are on, the receiver can be turned on by pressing [ON/STANDBY].

Auto Power On

If you start iPod/iPhone playback while the receiver is on Standby, the receiver will automatically turn on and select your iPod/iPhone as the input source.

Direct Change

If you start iPod/iPhone playback while listening to another input source, the receiver will automatically switch to the input to which the RI Dock is connected.

Other Remote Controllers

You can use the remote controller that came with the receiver to control other iPod/iPhone functions. The available functionality depends on the receiver.

iPod/iPhone Alarm

If you use the Alarm function on your iPod/iPhone to start playback, the receiver will turn on at the specified time and select your iPod/iPhone as the input source automatically.

Notes:

- Linked operations do not work with video playback or when the alarm is set to play a sound.
- If you use your iPod/iPhone with any other accessories, iPod/iPhone playback detection may not work.

Controlling Your iPod/iPhone

See the Dock's instruction manual for more information.

- Set the RI Dock's RI MODE switch to "HDD" or "HDD/DOCK".
- You can control your iPod/iPhone when "DOCK" is selected as the input source.

Press the **DOCK** button first.

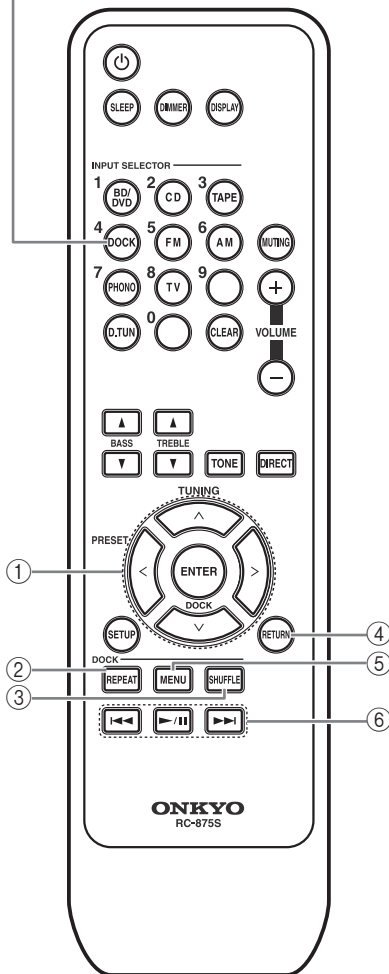

Available buttons:

- ① \wedge/\vee , ENTER
- ② REPEAT
- ③ SHUFFLE
- ④ RETURN
- ⑤ MENU
- ⑥ $\blacktriangleleft/\parallel/\blacktriangleright$

Note:

Some buttons may not be available depending on your RI Dock.

Notes:

- With some iPod/iPhone models or generations, or some RI Docks, certain buttons may not work as expected.
- For details on operating your iPod/iPhone, please refer to the instruction manual of the RI Dock

Troubleshooting

If you have any trouble using the receiver, look for a solution in this section.

If you can't resolve the issue yourself, try resetting the receiver before contacting your Onkyo dealer.

To reset the receiver to its factory defaults, turn it on and, while holding down the [TUNING MODE] button, press the [ON/STANDBY] button.

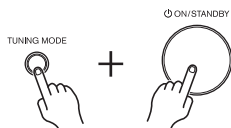

Note that resetting the receiver will delete your radio presets and custom settings.

Power

Can't turn on the receiver

- Make sure that the power cord is plugged into the electric outlet properly.
- Unplug the power cord from the electric outlet, wait 5 seconds or more, then plug it in again.

Audio

There's no sound or it's very quiet

- Make sure the speaker set A or B is on (→ page 20).
- Make sure that all audio connecting plugs are pushed in all the way (→ page 15-18).
- Make sure that the polarity of the speaker cables is correct, and that the bare wire is in contact with the metal part of each speaker terminal (→ page 11).
- Make sure that the speaker cables are not shorting.
- Make sure that the inputs and outputs of all components are connected properly.
- Make sure that the correct input source is selected (→ page 20).
- If the MUTING indicator is shown on the display, press the remote controller's [MUTING] button to unmute the receiver (→ page 20).
- If your turntable uses an MC cartridge, you must connect an MC head amp, or an MC transformer and a phono preamp.
- While a pair of headphones is connected to the PHONES jack, no sound is output from the speakers. (→ page 20).

Noise can be heard

- Using cable ties to bundle audio cables with power cords, speaker cables, and so on may degrade the audio performance; do not bundle audio cables together with power cords or speaker cables.
- An audio cable may be picking up interference. Try repositioning your cables.

The tone controls have no effect

- If the DIRECT is turned on, the tone controls have no effect. Press the [TONE] button to turn the function off.

Tuner

Reception is noisy, stereo FM reception suffers from hiss, or the FM STEREO indicator doesn't appear

- Relocate your antenna.
- Move the receiver away from your TV or computer.
- Listen to the station in mono (→ page 24).
- When listening to an AM station, operating the remote controller may cause noise.
- Passing cars and airplanes can cause interference.
- Concrete walls weaken radio signals.
- If nothing improves the reception, install an outdoor antenna.

Remote Controller

The remote controller doesn't work

- Make sure that the batteries are installed with the correct polarity (→ page 6).
- Install new batteries. Don't mix different types of batteries or old and new batteries (→ page 6).
- Make sure that the remote controller is not too far away from the receiver, and that there's no obstruction between the remote controller and the receiver's remote control sensor (→ page 6).
- Make sure that the receiver is not subjected to direct sunshine or inverter-type florescent lights. Relocate if necessary (→ page 6).

Can't control other components

- If it is an Onkyo component, make sure that the **RI** cable and analog audio cable are connected properly. Connecting only an **RI** cable won't work (→ page 17).
- With some components, certain buttons may not work as expected, and some may not work at all.
- To control an Onkyo component that's connected via **RI**, point the remote controller at the receiver.

Recording

Can't record

- On your recorder, make sure the correct input is selected.
- To prevent signal loops and damage to the receiver, input signals are not fed through to outputs with the same name (e.g., TAPE IN to TAPE OUT).

Others

The functions don't work

- To use **RI**, you must make an **RI** connection and an analog audio connection (RCA) between the component and receiver, even if they are connected digitally (→ page 17).

The receiver contains a microcomputer for signal processing and control functions. In very rare situations, severe interference, noise from an external source, or static electricity may cause it to lockup. In the unlikely event that this happens, unplug the power cord from the wall outlet, wait at least five seconds, and then plug it back in again.

Onkyo is not responsible for damages (such as CD rental fees) due to unsuccessful recordings caused by the unit's malfunction. Before you record important data, make sure that the material will be recorded correctly.

Before disconnecting the power cord from the wall outlet, set the receiver to Standby.

Specifications

Amplifier Section

| | |
|--|--|
| Rated Output Power | (North American) 50 watts minimum continuous power per channel, 8 Ω loads, 2 channels driven from 20 Hz to 20 kHz with a maximum total harmonic distortion of 0.08 % (FTC) (European) 2 ch \times 90 W at 6 Ω , 1 kHz, 1 ch driven of 1 % (IEC) |
| Dynamic Power | 180 W (3 Ω , Front) 160 W (4 Ω , Front) 100 W (8 Ω , Front) |
| THD +N (Total Harmonic Distortion +Noise) | 0.03 % (20 Hz–20 kHz, half power) |
| Damping Factor | 60 (1 kHz, 8 Ω) |
| Input Sensitivity and Impedance (Un balance) | 200 mV/ 47 k Ω (LINE) 2.5 mV/ 47 k Ω (PHONO MM) |
| Rated RCA Output Level and Impedance | 200 mV/ 2.2 k Ω (REC OUT) |
| Maximum RCA Output Level and Impedance | 2 V/2.2 k Ω (REC OUT) |
| Phono Overload | 70 mV (MM, 1 kHz, 0.5%) |
| Frequency Response | 10 Hz–100 kHz/ +1 dB–3 dB (CD) |
| Tone Control Characteristics | \pm 11 dB, 100 Hz (BASS) \pm 11 dB, 10 kHz (TREBLE) |
| Signal to Noise Ratio | 100 dB (CD, IHF-A) 80 dB (PHONO MM, IHF-A) |
| Speaker Impedance | 4 Ω –16 Ω |

Tuner Section

■ FM

| | |
|------------------------|---|
| Tuning Frequency Range | (North American) 87.5 MHz–107.9 MHz (European) 87.5 MHz–108.0 MHz, RDS |
|------------------------|---|

■ AM

| | |
|------------------------|---|
| Tuning Frequency Range | (North American) 530 kHz–1710 kHz (European) 522/530 kHz–1611/1710 kHz |
| Preset Channel | 40 |

General

| | |
|--------------------------------------|--|
| Power Supply | (North American) AC 120 V, 60 Hz (European) AC 230 V, 50 Hz |
| Power Consumption | (North American) 180 W (European) 170 W |
| No-sound Power Consumption | (North American) 30 W (European) 35 W |
| Stand-by Power Consumption | (North American) 0.15 W (European) 0.25 W |
| Dimensions (W \times H \times D) | 435 \times 150 \times 328.5 mm (17-1/8" \times 5-7/8" \times 12-15/16") |
| Weight | 7.3 kg (16.1 lbs.) |

■ Audio Inputs

Analog Inputs PHONO, CD, DOCK, TAPE, TV, BD/DVD

Digital Inputs OPTICAL: TV
(European model only) COAXIAL: CD, BD/DVD

■ Audio Outputs

Analog Outputs TAPE
Pre Outputs SUBWOOFER
Speaker Outputs SPEAKERS A
SPEAKERS B
Phones 1 (6.3 ϕ)

■ Others

 1

Specifications and features are subject to change without notice.

Memo

ONKYO

Onkyo Corporation
2-1, Nisshin-cho, Neyagawa-shi, OSAKA 572-8540, JAPAN
<http://www.onkyo.com/>

The Americas

Onkyo U.S.A. Corporation
18 Park Way, Upper Saddle River, N.J. 07458, U.S.A.
For Dealer, Service, Order and all other Business Inquiries:
Tel: 201-785-2600 Fax: 201-785-2650
<http://www.us.onkyo.com/>

For Product Support Team Only:
1-800-229-1687
<http://www.us.onkyo.com/>

Europe

Onkyo Europe Electronics GmbH
Liegnitzerstrasse 6, 82194 Groebenzell, GERMANY
Tel: +49-8142-4401-0 Fax: +49-8142-4208-213
<http://www.eu.onkyo.com/>

Onkyo Europe Electronics GmbH (UK Branch)
Meridien House, Ground floor, 69 - 71 Clarendon Road, Watford, Hertfordshire, WD17 1DS, United Kingdom
Tel: +44 (0)8712-00-19-96 Fax: +44 (0)8712-00-19-95

China

Onkyo China Limited (Hong Kong)
Unit 1033, 10/F, Star House, No 3, Salisbury Road, Tsim Sha Tsui Kowloon, Hong Kong.
Tel: 852-2429-3118 Fax: 852-2428-9039
<http://www.hk.onkyo.com/>

Onkyo China PRC (Mainland)
1301, 555 Tower, No.555 West NanJing Road, Jing'an District, Shanghai, China 200041,
Tel: 86-21-52131366 Fax: 86-21-52130396
<http://www.cn.onkyo.com/>

Asia, Oceania, Middle East, Africa

Please contact an Onkyo distributor referring to Onkyo SUPPORT site.
<http://www.intl.onkyo.com/support/>

The above-mentioned information is subject to change without prior notice.
Visit the Onkyo web site for the latest update.

I1306-1

SN 29401517

(C) Copyright 2013 Onkyo Corporation Japan. All rights reserved.



* 2 9 4 0 1 5 1 7 *